

# Investigation of Physiological Mechanism For Linking Field Synapses

Richard B. Wells<sup>1</sup>, Nick Garrett<sup>2</sup>, Tom Richner<sup>3</sup>

Microelectronics Research and  
Communications Institute (MRCI)

BEL 316

University of Idaho

Moscow, ID 83844-1024

<sup>1</sup>The author is with the MRCI, University of Idaho.

<sup>2</sup>The author is with the MRCI. He is now at Wake Forest University.

<sup>3</sup>The author is with the MRCI. He is now at Washington University.

Corresponding Author:

Richard B. Wells, Ph.D.  
Telephone: (208) 885-4353  
Fax: (208) 885-6840  
Email: [rwells@mrc.uidaho.edu](mailto:rwells@mrc.uidaho.edu)

## **Introduction**

This paper discusses the implementation of linking field synapses into the Wilson model of cortical neurons. To our knowledge nobody has investigated the effects of implementing such synapses into biologically accurate models of neural networks. The reason for this investigation is to propose a biologically accurate model for synchronization observed in the visual cortex of cats by Reinhard Eckhorn (Eckhorn 1990). Eckhorn has previously modeled this phenomenon using a linking field (LF) that links several neurons together to facilitate “group firing”, and as such, synchronization. The Eckhorn model is abstract and distance from biological parameters. The model is successful at modeling synchronization but not in a biologically-known manner. The main objective in our investigation is to take the LF from Eckhorn’s model and apply it to the Wilson model to achieve biological interpretation of parameters while keeping the synchronization phenomenon intact.

The Eckhorn neuron is shown in Figure 1. The unique feature of the neuron is its incorporated linking field. The linking field acts as a variable gain element that helps to weight the inputs arriving at the neuron and thus produce synchronization. The linking field has an excitatory post synaptic potential (EPSP) time constant  $\approx 1-2$  ms. The feeding field (FF) is  $\approx 10$  ms.

Eckhorn’s model is a great example of a phenomenological model. If it is to represent a biologically feasible phenomenon then there must be some biological mechanism present to produce the phenomenon. The issue in this case is that no such mechanism has yet been reported. The small time constant of the LF suggests that it only involves AMPA receptors while the FF is a combination of both AMPA and NMDA receptors. The LF time constant also rules out the possibility of the effects coming from metabotropic modulators.

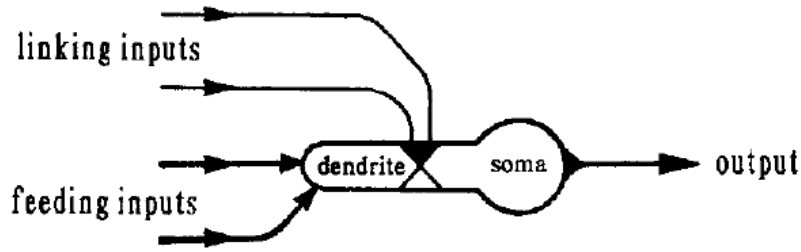

**Figure 1: The Eckhorn neuron model.**

The basic idea behind the model is that the FF incorporates a specific ratio of AMPA and NMDA receptors to allow partial opening of the NMDA receptors during normal operations. The integrator loss dynamic of the model is represented in Figure 2. When many inputs arrive in parallel within a brief time of each other the LF-AMPA current produced by such inputs causes significantly more voltage-dependent NMDA receptors to open. This allows for more control over action potentials (AP) and gives the model the ability to synchronize under the right conditions.

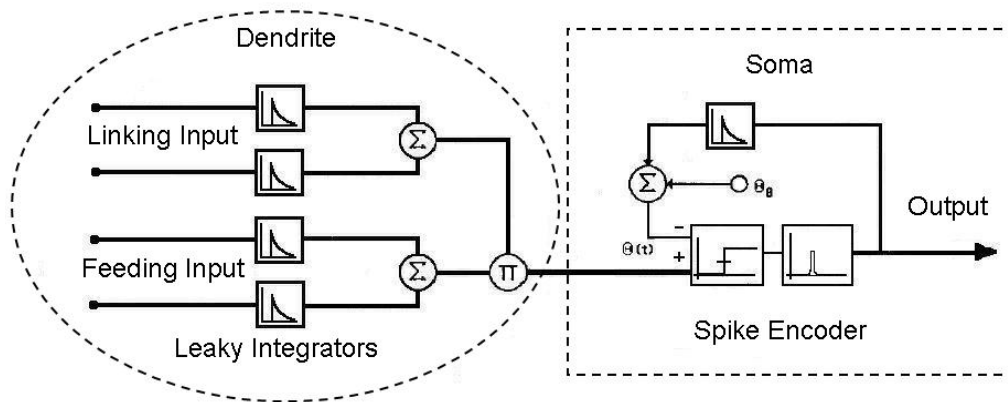

Figure 2. Diagram of Eckhorn neuron showing integrator loss function.

Eckhorn's model can be incorporated into the layers found in cortex by using the schematic shown (Figure 3).

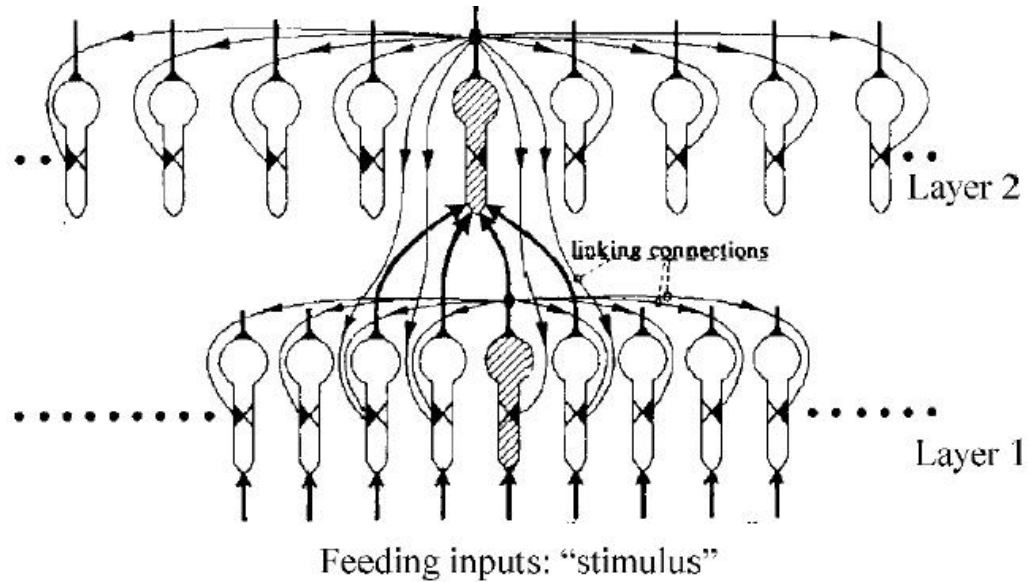

Figure 3. Eckhorn neurons incorporated into cortex layers.

The idea behind the layers is that several neurons will be linked with each other and will each individually link to a set of common neurons in the next layer as shown. The next layer also contains an inhibitory feedback loop that regulates the previous layers firing.

It is presently unknown whether synapses in the neocortex can exist as AMPA-only synapses. One of the key assumptions in our research is that synapses where AMPA receptors greatly outnumber NMDA receptors could exist. We model the extreme case where all the LF synapse receptors are AMPA. We make the hypothesis that these AMPA-only LF inputs are present and contribute to the synchronization phenomenon observed by Eckhorn. The LF can never generate an action potential by itself while the FF inputs can generate action potentials by themselves provided that enough inputs arrive simultaneously.

The model we chose to use as a biologically accurate representation of a cortex neuron was based on Hugh Wilson's simplified neuron model. Wilson's model is a simplified neuron based on the work done by Hodgkin and Huxley (Wilson 1999). It includes only four currents;

$I_{Na}$ ,  $I_K$ ,  $I_T$ , and  $I_{AHP}$ . Wilson's model includes Ohm's law and the equilibrium potentials for  $Na^+$ ,  $K^+$ , and  $Ca^{2+}$  (Wilson 1999). Wilson achieves a simplified model by restricting the values to cubic nonlinearities. A schematic of Wilson's model is shown in Figure 4. Matlab code was developed from a based provided by (Trappenberg).

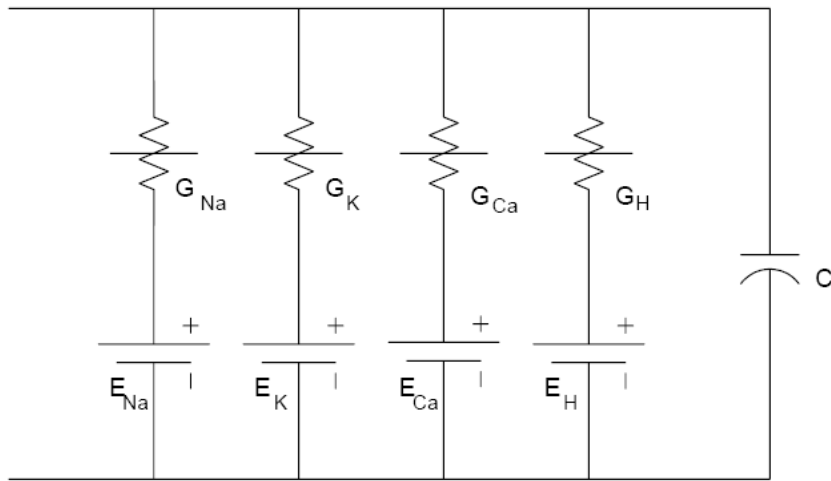

Figure 4. A schematic of Wilson's model of cortical neurons.

Using the Wilson neuron with AMPA and NMDA synapses we investigated three characteristic dynamics that have previously been found in Eckhorn networks. First, we tested the ability of the linking field to synchronize inputs within a small temporal window. Second, we tested a single Wilson neuron for high pass filter (HPF) capability. Lastly, working with the kernel, we tested the effectiveness of the inhibitory neuron to packet the activity of the excitatory neurons.

Essential to Eckhorn neurons are the feeding field and linking field inputs. Having two types of input allow layered networks of neurons to create wave activity like that in the visual cortex. Conceptually, the linking field is responsible for maintaining local synchrony. Without the linking field, wave activity would likely not be stable.

Eckhorn neurons are known to readily high pass filter (Wells et al.). High pass filtering is an important information processing technique that may be present in the cortex. Gamma frequency signals are known to propagate readily while lower frequency signals do not.

The Eckhorn model has been shown to exhibit phenomena known as “packeting” (Wells et al.). Packeting is a dynamic that can exist when a kernel acts as a pass band and bursts of spikes and time intervals of inhibition. It is essential that the inhibitory neuron be able to inhibit the excitatory neurons in the kernel to exhibit packeting or else the neurons will continue to fire continuously. An example of inhibition is shown in Figure 5 and is taken from Wells et al.

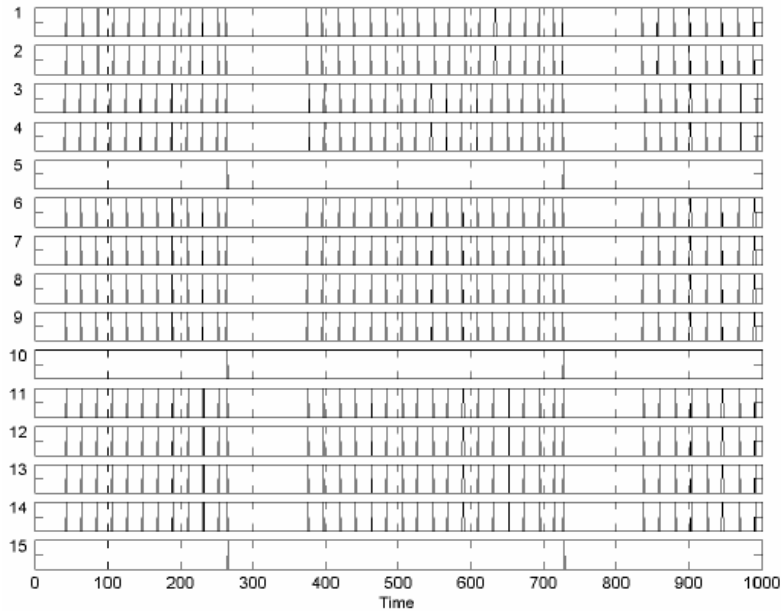

Figure 5. Example of pass-band packeting from a Eckhorn kernel.

## Methods

Our network modeled Eckhorn's layers. We constructed two kernels (layers) that consisted of 5 neurons each; 4 excitatory neurons and 1 inhibitory neuron (Figure 6).

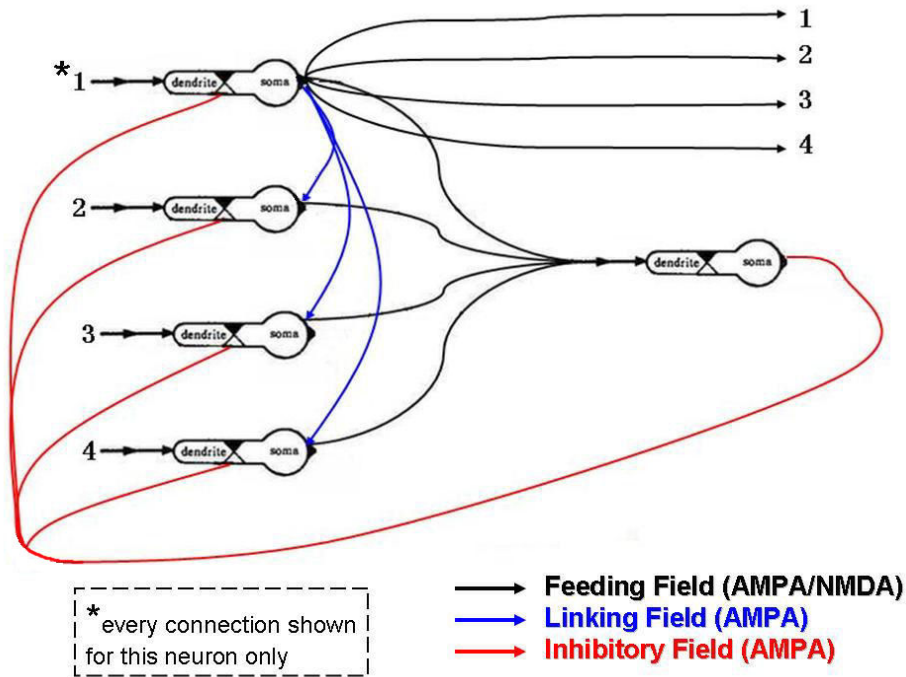

Figure 6: Schematic of 1 kernel.

The first four neurons in kernel 1 receive their input as an external artificial input. They feed in equally (1:1:1:1) into the inhibitory neuron. The inhibitory feeds 95% of its output back into the 4 excitatory neurons as ionotropic inhibition. The remaining 5% is fed forward to the inhibitory neuron in kernel 2. The four excitatory neurons in kernel 1 also feed their input equally into all four excitatory neurons of kernel 2. For example, neuron 1 of kernel 1 would feed an equal amount of input to the inhibitory neuron of kernel 1 and to the four excitatory neurons of kernel 2. This insures that the neurons in kernel 2 require input from all four excitatory neurons of kernel 1. A schematic of our altered Wilson model is shown in Figure 7.

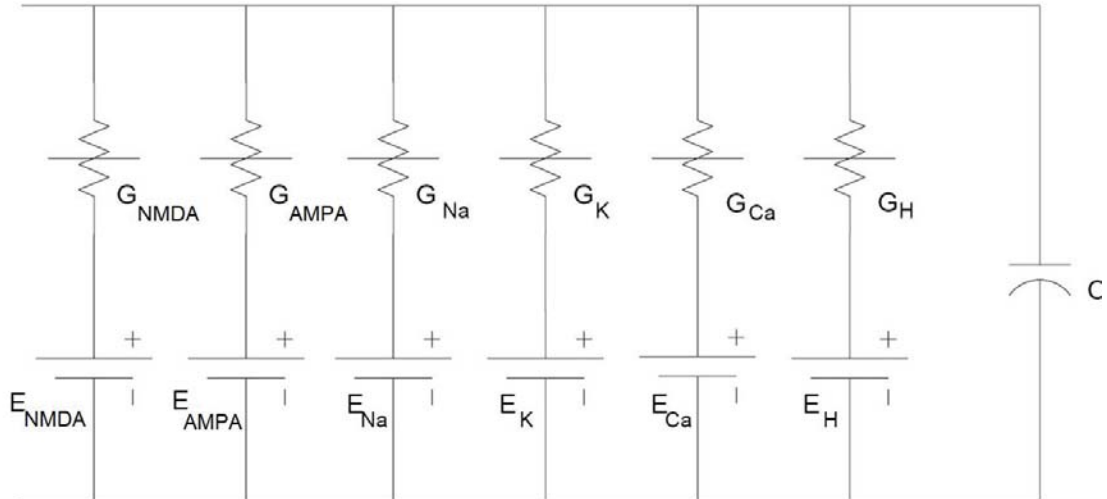

Figure 7. Schematic of the Wilson model with AMA and NMDA synapses added.

### Linking Field

To test the linking field of the Wilson kernel, inputs were given sequentially to each of the four RS neurons with a small known temporal spacing. The temporal spacing from the output of the kernel were recorded and compared to the input. If the output spacing was smaller than the input spacing, then we conclude that the linking field functioned to increase the synchrony of the input signals.

Detailed procedure:

1. Two kernels are used. Kernel 1 is used to filter out anomalies of the artificial input. The test is done on kernel 2. Weights from kernel 1 are set so that RS1 of Kernel 1 feeds to RS1 of kernel2, RS2 of kernel 1 feeds to RS2 of kernel 2. Each kernel receives its own input this way. See Table 1.



	RS1, K2	RS2, K2	RS3, K3	RS4, K4
source RS1, K1	1	0	0	0
RS2, K1	0	1	0	0
RS3, K1	0	0	1	
RS4, K1	0	0	0	1

Table 1. Weight matrix from kernel 1 to kernel 2 used in linking field test.

2. An input of 85 ms is given to RS1 of kernel 1 at  $t=0$ . Input is given to RS2 of kernel 1 at  $t=\text{input Spacing}$ , where input Spacing is a parameter in milliseconds. Input is given to RS3 of kernel 1 at  $t=2*\text{input Spacing}$ , and input is given to RS4 of kernel 1 at  $t=3*\text{input Spacing}$ .
3. Kernel 1 passes all input through to kernel 2.
4. The time of the spike times of kernel 2 are recorded as output. The average outputSpacing is calculated.
5. Increased synchronization % is calculated by  $(\text{inputSpacing}-\text{outputSpacing})/\text{inputSpacing}$ .
6. The procedure was repeated multiple times while inputSpacing is varied from 1.25 to 15.0 milliseconds in 0.25 increments.

### High Pass Filter

The Eckhorn neuron is well designed to HPF, because it has integrator loss and a relatively small refractory period compared to the feeding field. Integrator loss is where one or more presynaptic input spikes do not cause the neuron to spike. A neuron that requires three spikes within a certain time range to spike has an integrator loss of 2 spikes. The third presynaptic spike is thought of as causing the neuron's spike. Integrator loss is necessary, because the frequency of an input cannot be determined from a single spike. Thus an integrator loss of 1 spike was requirement when testing the Wilson neuron for HPF ability. A neuron's refractory

period is the time following a spikes when the neuron is not able to spike again. The Eckhorn neuron has a refractory time constant of just 5 milliseconds, so it could spike with a frequency as high as 200 Hz. By definition of HPF, the output frequency must be equal to the input frequency. We used this as another requirement for HPF in our test.

After attempting to hand adjust the parameters of a Wilson neuron with RS constants to achieve HPF, we decided to write a script to systematically adjust the parameters with nested for-loops. The input frequency and the amount of AMPA and NMDA were varied within biological ranges. Code was written to identify the output frequency and integrator loss.

## Results

### Linking Field

Quantitatively, synchronization was defined to be the range in time from the first spike to the last spike of a signal. Figure 8 gives an example of how increased synchronization was measured.

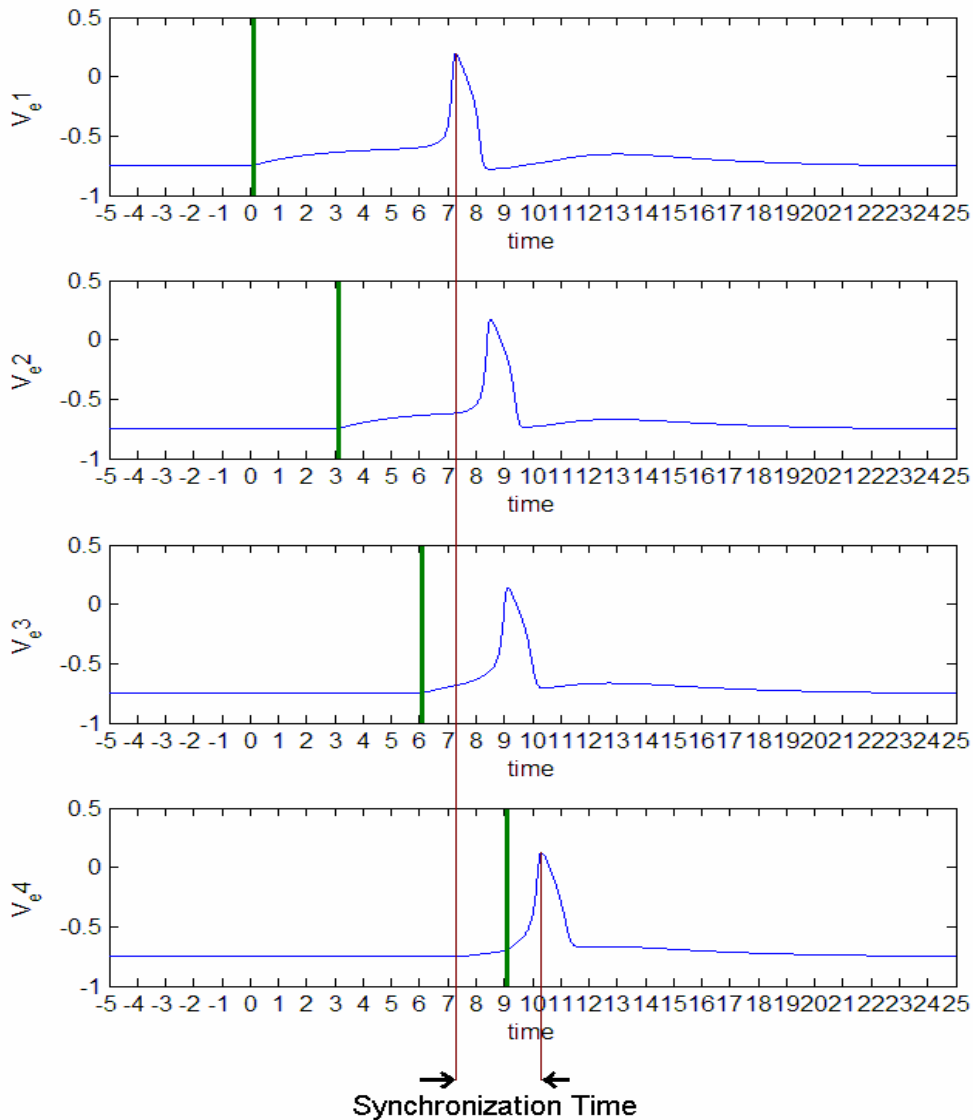

Figure 8. Example linking field test trial. Note that the time between the vertical green line on the first neuron and the green line of the last neuron is greater than the time between the two vertical red lines. This demonstrates increased synchronization due to the linking field.

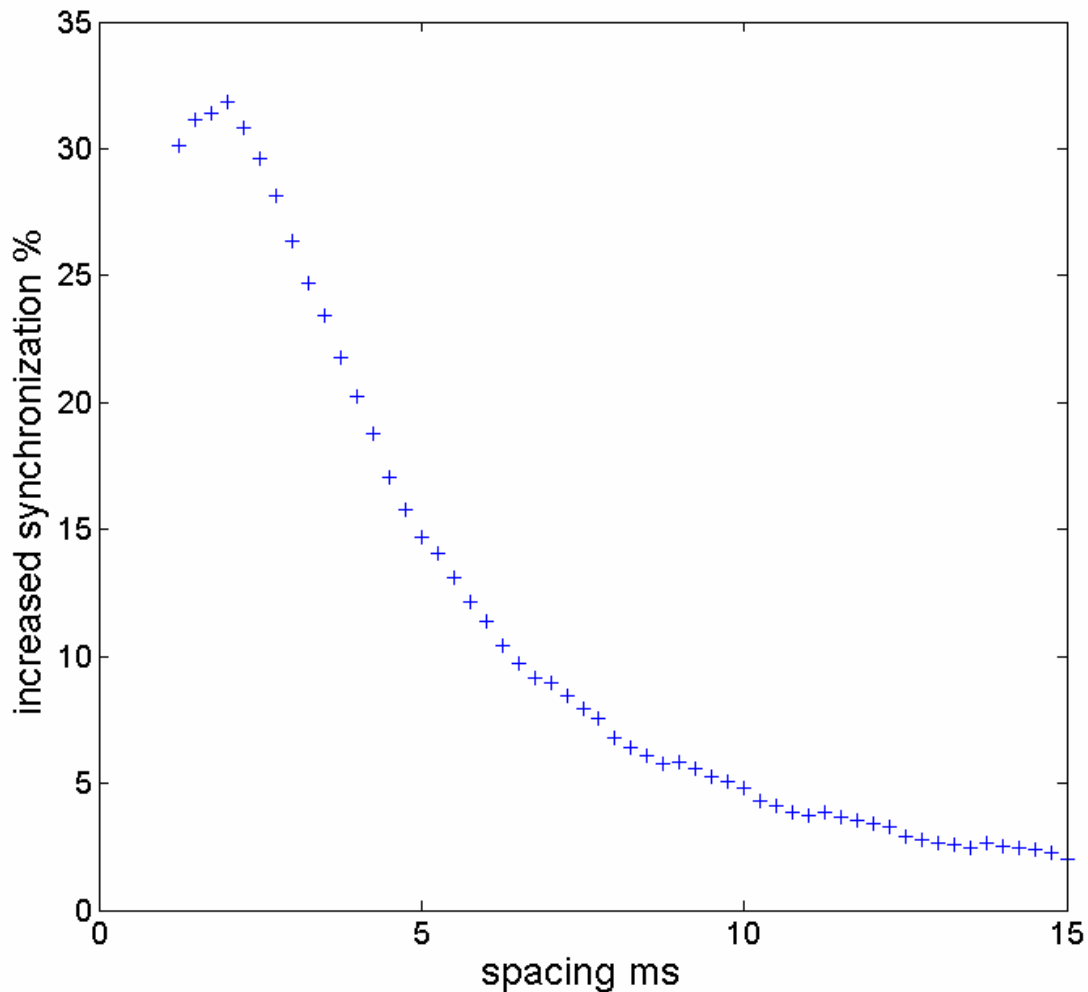

Figure 9. As the temporal spacing between inputs is increased, the ability of the linking field to synchronize the inputs decreases.

Figure 9 shows the temporal linking window. Interestingly, the linking field was most effective with input spacings around 2.5 ms. We attribute to the delayed spiking. When an input was given to a neuron, several milliseconds passed before a spike. Thus when an input spacing of just 1.25 milliseconds is small in comparison to the delay before a spike, and the other neurons quite near spiking when RS1 spikes and sends linking field input the other neurons. We also note that most linking effect is within 5 milliseconds which is similar to what would be expected biologically.

As expected, we observed that output spacing between RS1 and RS2 was greater than the other output spacings. This is because RS2 receives linking field input only from RS1, but the other neurons receive input from RS1, RS2, etc.

### High Pass Filter

The data were analyzed for integrator loss and for input-output frequency similarity to determine if any set of parameters yielded HPF activity. None were found. The number of AMPA and NMDA synapses were varied from 0 to 25, and the input frequency was varied from 14 to 200 Hz. 735 points in this search space were checked. All pass filters did occur, but none were frequency selective, because they occurred with the number of AMPA and NMDA synapses set to high values.

### Packeting

Packeting in our kernel depending on two factors; the ability of our kernel to exhibit pass-band dynamics (HPF +HPF) and a inhibitory neuron capable of inhibiting the kernel. Neither of these factors worked in our kernel and subsequently we did not observe packeting. Figure 10 shows that under normal biological conditions, the kernel shows no inhibition or packeting. Figure 11 shows that even under intense inhibition (10X biological parameters) the kernel still is not inhibited.

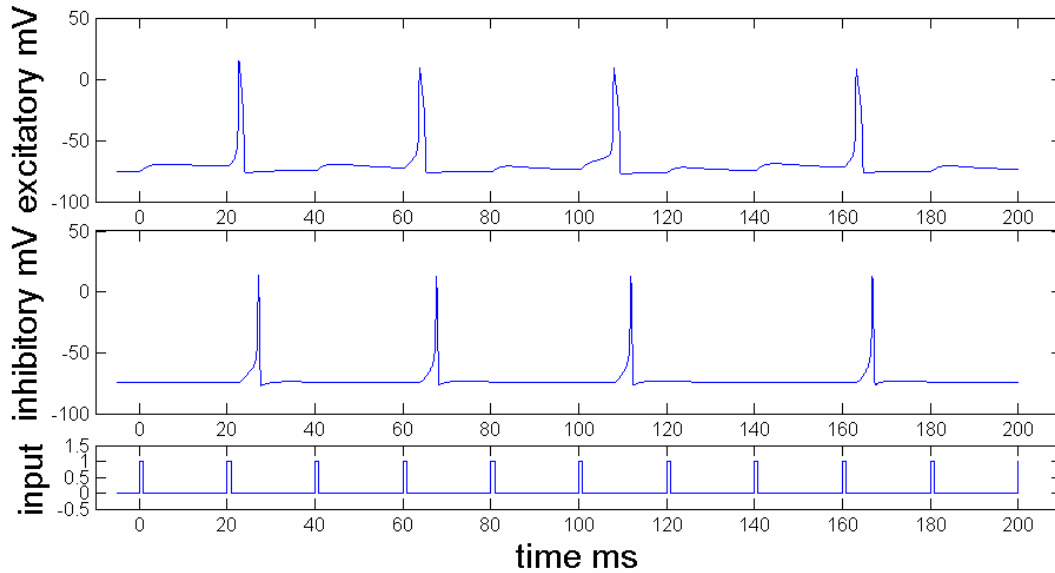

Figure 10. Graph showing no inhibition of the kernel within biological ranges.

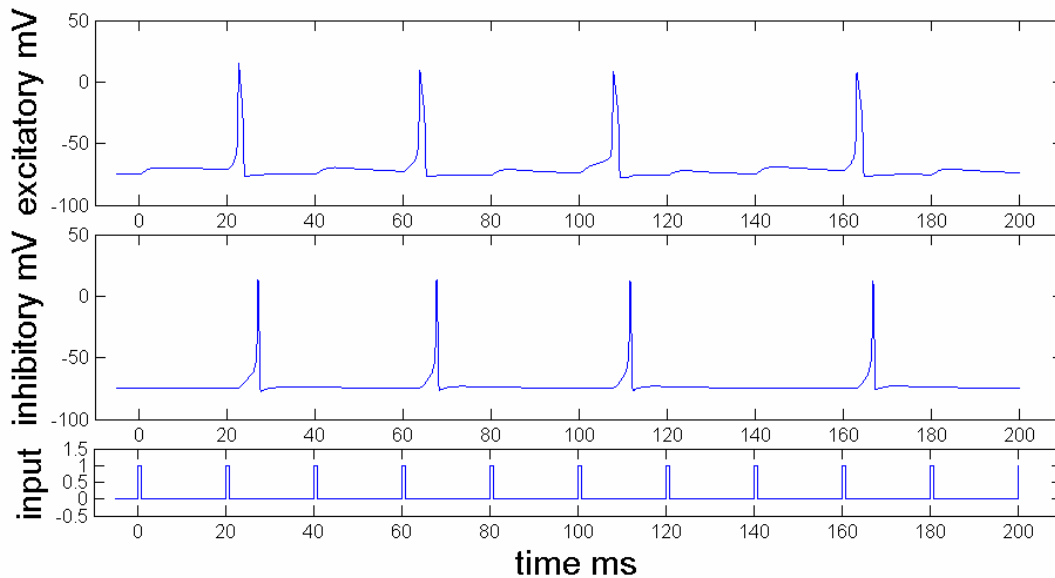

Figure 11. Graph showing no inhibition of the kernel with extreme values for the inhibitory neuron.

We conjecture that the lack of inhibition is due to the feeding field coming from the inhibitory neuron. This synapse is modeled as an ionotropic synapse and as such the time constant is very small. This small time constant does not provide a long enough inhibition to cause packeting or to stop the excitatory neurons from spiking. It has been shown that GABA<sub>A</sub> synapses are not successful at inhibiting neurons unless mediated or combined with other synapses with varying time constants (Russier).

## **Discussion**

Not finding HPFs was not surprising, because the Wilson neuron has a considerable refractory period determined by its potassium hyperpolarization current. The hyperpolarization conductance has a time constant of 45 milliseconds. It “competes” with the 40 millisecond time constant of the NMDA conductance. At high frequencies, the NMDA conductance climbs, but so too does the hyperpolarization conductance. As evidence, we found that when the time constant of the NMDA was adjusted to a biologically unrealistic value greater than 100 milliseconds, the NMDA conductance would be significantly larger than the hyperpolarization conductance and mediate re-firing.

The Eckhorn model is quite abstract, and it would not be unreasonable to think of each Eckhorn neuron representing more than one physiological neuron. Thus it may very well be the case that multiple Wilson neurons would be necessary for HPF activity. We conjecture that a small highly recurrent network of Wilson neurons could HPF.

The linking field is a possible mechanism to aid in coincidence detection. The linking field has the ability to increase the effective synchronization of two signals (figure 9). Hebbian learning rules use a correlation term based on two signals being propagated within a small temporal window. (Gerstner, pg. 378). Gerstner suggested that dendritic back propagation of an action potential would facilitate coincidence detection with NMDA receptors. Since NMDA receptors require glutamate and are voltage dependent, the voltage can be biased towards spiking quickly while the presence of glutamate in a synapse is still controlled by the presynaptic neuron. The linking field’s ability to create subthreshold potentiation would aid in dendritic backpropagation. We must note, however, that the neuron model used in our simulation is single-compartmental. Thus, no dendritic back propagation of membrane potential was tested.

Wells et al., Biological Linking Fields

Whether subthreshold potentiation due to the linking field can backpropagate with significant effect should be analyzed using cable theory. We hypothesize that linking field synapses would have to quite close spatially to the NMDA rich synapses.

It would be interesting to create a Wilson neural network with a linking field that could dynamically vary its AMPA to NMDA ratio. Different rules governing how AMPA to NMDA ratios are adjusted could be tested. We hypothesize that this model could demonstrate a type of Hebbian learning.

In conclusion, a biological basis for the linking field was found, HPF activity of a single neuron was not found, and packeting did not work with an ionotropic inhibitory synapse.



## Works Cited

Dayan, Peter & Abbot, L. F. *Theoretical Neuroscience: Computational and Mathematical Modeling of Neural Systems*. Cambridge, MA: MIT Press, 2001.

Eckhorn R, Reitboeck HJ, Arndt M, and Dicke P (1990) Feature linking via synchronization among distributed assemblies: Simulations of results from cat visual cortex, *Neural Computat.* 2: 293-307.

Gerstner, Wulfram & Kistler, Werner. *Spiking neuron Models*. Cambridge: Cambridge University Press, 2002.

Koch, Christof. *Biophysics of Computation: Information Processing in Single Neurons*. New York: Oxford University Press, 1999.

Russier M, Kopysova I, Ankri N, Ferrand N, Debanne D (2002) GABA and glycine co-release optimizes functional inhibition in rat brainstem motoneurons *in vitro*, *J of Phys.* 541.1: 123-137

Trappenberg, Thomas. *Fundamentals of Computational Neuroscience*. Oxford: Oxford University Press, 2002.

Wilson H (1999) Simplified Dynamics of Human and Mammalian Neocortical Neurons, *J. theor. Biol.* 200: 375-388.